

Redfish Inspections

Property Inspection Report



123 Easy Street, Houston, TX 77035
Inspection prepared for: Home Owner
Real Estate Agent: -

Date of Inspection: 10/14/2016 Time: 8:30 AM; 10:30 AM
Age of Home: 58 years old Size: 1853 sqf
Weather: Overcast

Inspector: William Misegades
TREC# 10465; Mark Wright TREC# 20893
2324 Pasqua Tr, League City, TX 77573
Phone: 713-568-8184
Email: info@redfishinspections.com
redfishinspections.com

PROPERTY INSPECTION REPORT

Prepared For:	Home Owner	
	<small>(Name of Client)</small>	
Concerning:	123 Easy Street, Houston TX, 77035	
	<small>(Address or Other Identification of Inspected Property)</small>	
By:	William Misegades, TREC# 10465; Mark Wright TREC# 20893	10/14/2016
	<small>(Name and License Number of Inspector)</small>	<small>(Date)</small>

PURPOSE, LIMITATIONS AND INSPECTOR / CLIENT RESPONSIBILITIES

This property inspection report may include an inspection agreement (contract), addenda, and other information related to property conditions. If any item or comment is unclear, you should ask the inspector to clarify the findings. It is important that you carefully read ALL of this information.

This inspection is subject to the rules ("Rules") of the Texas Real Estate Commission ("TREC"), which can be found at www.trec.texas.gov.

The TREC Standards of Practice (Sections 535.227-535.233 of the Rules) are the minimum standards for inspections by TREC licensed inspectors. An inspection addresses only those components and conditions that are present, visible, and accessible at the time of the inspection. While there may be other parts, components or systems present, only those items specifically noted as being inspected were inspected. The inspector is NOT required to turn on decommissioned equipment, systems, utility services or apply an open flame or light a pilot to operate any appliance. The inspector is NOT required to climb over obstacles, move furnishings or stored items. The inspection report may address issues that are code-based or may refer to a particular code; however, this is NOT a code compliance inspection and does NOT verify compliance with manufacturer's installation instructions. The inspection does NOT imply insurability or warrantability of the structure or its components. Although some safety issues may be addressed in this report, this inspection is NOT a safety/code inspection, and the inspector is NOT required to identify all potential hazards.

In this report, the inspector shall indicate, by checking the appropriate boxes on the form, whether each item was inspected, not inspected, not present or deficient and explain the findings in the corresponding section in the body of the report form. The inspector must check the Deficient (D) box if a condition exists that adversely and materially affects the performance of a system or component or constitutes a hazard to life, limb or property as specified by the TREC Standards of Practice. General deficiencies include inoperability, material distress, water penetration, damage, deterioration, missing components, and unsuitable installation. Comments may be provided by the inspector whether or not an item is deemed deficient. The inspector is not required to prioritize or emphasize the importance of one deficiency over another.

Some items reported may be considered life-safety upgrades to the property. For more information, refer to Texas Real Estate Consumer Notice Concerning Recognized Hazards or Deficiencies below.

THIS PROPERTY INSPECTION IS NOT A TECHNICALLY EXHAUSTIVE INSPECTION OF THE STRUCTURE, SYSTEMS OR COMPONENTS. The inspection may not reveal all deficiencies. A real estate inspection helps to reduce some of the risk involved in purchasing a home, but it cannot eliminate these risks, nor can the inspection anticipate future events or changes in performance due to changes in use or occupancy. It is recommended that you obtain as much information as is available about this property, including any seller's disclosures, previous inspection reports, engineering reports, building/remodeling permits, and reports performed for or by relocation companies, municipal inspection departments, lenders, insurers, and appraisers. You should also attempt to determine whether repairs, renovation, remodeling, additions, or other such activities have taken place at this property. It is not the inspector's responsibility to confirm that information obtained from these sources is complete or accurate or that this inspection is consistent with the opinions expressed in previous or future reports.

ITEMS IDENTIFIED IN THE REPORT DO NOT OBLIGATE ANY PARTY TO MAKE REPAIRS OR TAKE OTHER ACTIONS, NOR IS THE PURCHASER REQUIRED TO REQUEST THAT THE SELLER TAKE ANY ACTION. When a deficiency is reported, it is the client's responsibility to obtain further evaluations and/or cost estimates from qualified service professionals. Any such follow-up should take place prior to the expiration of any time limitations such as option periods.

Promulgated by the Texas Real Estate Commission (TREC) P.O. Box 12188, Austin, TX 78711-2188 (512) 936-3000
(<http://www.trec.texas.gov>).

Evaluations by qualified tradesmen may lead to the discovery of additional deficiencies which may involve additional repair costs. Failure to address deficiencies or comments noted in this report may lead to further damage of the structure or systems and add to the original repair costs. The inspector is not required to provide follow-up services to verify that proper repairs have been made.

Property conditions change with time and use. For example, mechanical devices can fail at any time, plumbing gaskets and seals may crack if the appliance or plumbing fixture is not used often, roof leaks can occur at any time regardless of the apparent condition of the roof, and the performance of the structure and the systems may change due to changes in use or occupancy, effects of weather, etc. These changes or repairs made to the structure after the inspection may render information contained herein obsolete or invalid. This report is provided for the specific benefit of the client named above and is based on observations at the time of the inspection. If you did not hire the inspector yourself, reliance on this report may provide incomplete or outdated information. Repairs, professional opinions or additional inspection reports may affect the meaning of the information in this report. It is recommended that you hire a licensed inspector to perform an inspection to meet your specific needs and to provide you with current information concerning this property.

TEXAS REAL ESTATE CONSUMER NOTICE CONCERNING HAZARDS OR DEFICIENCIES

Each year, Texans sustain property damage and are injured by accidents in the home. While some accidents may not be avoidable, many other accidents, injuries, and deaths may be avoided through the identification and repair of certain hazardous conditions.

Examples of such hazards include:

- malfunctioning, improperly installed, or missing ground fault circuit protection (GFCI) devices for electrical receptacles in garages, bathrooms, kitchens, and exterior areas;
- malfunctioning arc fault protection (AFCI) devices;
- ordinary glass in locations where modern construction techniques call for safety glass;
- malfunctioning or lack of fire safety features such as smoke alarms, fire-rated doors in certain locations, and functional emergency escape and rescue openings in bedrooms;
- malfunctioning carbon monoxide alarms;
- excessive spacing between balusters on stairways and porches;
- improperly installed appliances;
- improperly installed or defective safety devices;
- lack of electrical bonding and grounding; and
- lack of bonding on gas piping, including corrugated stainless steel tubing (CSST).

To ensure that consumers are informed of hazards such as these, the Texas Real Estate Commission (TREC) has adopted Standards of Practice requiring licensed inspectors to report these conditions as "Deficient" when performing an inspection for a buyer or seller, if they can be reasonably determined.

These conditions may not have violated building codes or common practices at the time of the construction of the home, or they may have been "grandfathered" because they were present prior to the adoption of codes prohibiting such conditions. While the TREC Standards of Practice do not require inspectors to perform a code compliance inspection, TREC considers the potential for injury or property loss from the hazards addressed in the Standards of Practice to be significant enough to warrant this notice.

Contract forms developed by TREC for use by its real estate licensees also inform the buyer of the right to have the home inspected and can provide an option clause permitting the buyer to terminate the contract within a specified time. Neither the Standards of Practice nor the TREC contract forms require a seller to remedy conditions revealed by an inspection. The decision to correct a hazard or any deficiency identified in an inspection report is left to the parties to the contract for the sale or purchase of the home.

INFORMATION INCLUDED UNDER "ADDITIONAL INFORMATION PROVIDED BY INSPECTOR", OR PROVIDED AS AN ATTACHMENT WITH THE STANDARD FORM, IS NOT REQUIRED BY THE COMMISSION AND MAY CONTAIN CONTRACTUAL TERMS BETWEEN THE INSPECTOR AND YOU, AS THE CLIENT. THE COMMISSION DOES NOT REGULATE CONTRACTUAL TERMS BETWEEN PARTIES. IF YOU DO NOT UNDERSTAND THE EFFECT OF ANY CONTRACTUAL TERM CONTAINED IN THIS SECTION OR ANY ATTACHMENTS, CONSULT AN ATTORNEY.

ADDITIONAL INFORMATION PROVIDED BY INSPECTOR

Type of inspection: Buyer's Inspection
Approximate age: 58 years old
Building Style: story, single family home

General Appearance: Good
Street Entrance Faces: West
State of Occupancy: Vacant

Weather Condition: Sunny
Ground Cover: Dry
Temperature: 84 F

This property was a 58 years old structure. As with all homes, ongoing maintenance is/will be required and improvements to the systems of the home will be needed over time. The improvements that are recommended in this report are not considered unusual for a home of this age and location. Please remember that there is no such thing as a perfect home.

Descriptions— When outside the structure, the terms "front," "left," "rear," and "right" were used to describe the structure as viewed from the front door, even if it does not face the address street. When inside the structure, the terms "front," "left," "rear," and "right" were used to describe the structure as viewed from the room entrance.

The structure's interior was inspected in a clockwise fashion. The first bedroom that comes up starting at the front door will be bedroom 1, then bedroom 2 etc... likewise for the bathrooms or any other multiple numbered rooms.

If you have any questions about room descriptions or locations, please contact us; it's important that you be able to identify the rooms that we discuss in your report.

Your report includes many photographs. Some pictures are intended as a courtesy and are added for your information only. Some are to help clarify where the inspector has been, what was looked at, and the condition of the system or component at the time of the inspection. Some of the pictures may be of deficiencies or problem areas. These are to help you better understand what is documented in this report and may allow you to see areas or items that you normally would not see. Some issues may be difficult to photograph or too numerous so not all problem areas or conditions will be supported with photos.

I=Inspected

NI=Not Inspected

NP=Not Present

D=Deficient

I	NI	NP	D
---	----	----	---

I. STRUCTURAL SYSTEMS

<input checked="" type="checkbox"/>	<input type="checkbox"/>	<input type="checkbox"/>	<input checked="" type="checkbox"/>	A. Foundations
-------------------------------------	--------------------------	--------------------------	-------------------------------------	----------------

Type of Foundation(s): **Slab Foundation**

Comments:

NOTE: The foundation performance opinion stated hereunder neither in any way addresses future foundation movement or settlement, nor does it certify floors to be level. Soil in the Houston Texas area is known to be unstable and unpredictable. Due to the expansive nature of the soil in this area, no warranty against future movement can be made. This inspector is not responsible for defects in the slab in areas that are not visible for inspection. The inspector does not perform any engineering studies or measurements such as geological, and hydrological stability test, soils conditions reports; wave action reporting; any form of engineering analysis. Only licensed engineers can conduct such evaluations. Should you have present or future concerns regarding the foundation's condition, you are strongly advised to consult with a licensed Professional Structural Engineer for further evaluation.

SLAB FOUNDATION

NOTE: A precision pressurized hydrostatic altimeter was used to measure the level of the foundation (the yellow rectangles photographed in this section). This data provided us with additional information to help us determine the performance of the foundation. Furthermore, this data included in the report will give the buyer a baseline for future movement.

The digital reader which the unit is in inches, was "zeroed" at the front door. A level/measurement was then taken at the different corners of the foundation and any other areas we considered necessary. A generally accepted standard of one half inch in 10 feet (1/5" in 10') was used to determine if the foundation was considered flat within tolerance.

Floor finishes such as carpet do affect the reading. About 0.3" to 0.5" is deducted from the reading to compensate for the carpet and padding thickness. These finishes are taken in consideration in our calculation of foundation level differential. We have not yet found a perfectly flat foundation.

Should you have any questions concerning this tool or data, please ask the inspectors.

FOUNDATION PERFORMANCE

In our opinion the foundation was not performing as intended by design. We recommend you retain a Professional Foundation Specialist for a second opinion concerning the performance of the foundation. The Professional you retain should have the specialized training to perform an engineering evaluation of the performance of the foundation. They can provide you with; 1) a second opinion concerning foundation performance, 2) an opinion as to whether foundation repair/adjustments is structurally necessary and 3) options in addition to foundation repair and adjustments that the engineer deems applicable to this

I=Inspected

NI=Not Inspected

NP=Not Present

D=Deficient

I	NI	NP	D
---	----	----	---

house.

Evidence found supporting the inspectors opinions includes:

- Resent diagonal cracks on interior walls
- Step cracks on exterior walls
- Doors needed to be adjusted

The structure had attaching slabs "expansion joints" between the driveway and the garage/house. This is a location for wood destroying insects (termites) to enter the home. Home owner needs to perform frequent inspections of these areas.

Hairline cracks were observed in the foundation slab of the house. These are not uncommon, where under 1/4 inch wide and should be monitored. This was noted in the entry, garage, and left.



Driveway/walk to foundation:
Monitor area for insect activity



Entry: hairline crack



Garage: Hairline crack



Front door



Bathroom 1



Bedroom 1

I=Inspected

NI=Not Inspected

NP=Not Present

D=Deficient

I	NI	NP	D
---	----	----	---



Bedroom 3 left



Bedroom 3 right



Sliding door



Kitchen



Garage man door



Dining to front room transition



Front room

X			X
---	--	--	---

B. Grading and Drainage

Comments:

FOLIAGE

Foliage was noted close to the structure, we recommend trimming all bushes away from structure. Bushes and trees too close to the structure can prevent the wall from drying properly, their roots can affect the foundation and their branches can damage the structure. This was located on the rear, and right.

SOIL

High soil was observed around the house. We recommend having 4 inches minimum clearance between soil/brick and 6 inches minimum clearance between

I=Inspected NI=Not Inspected NP=Not Present D=Deficient

I	NI	NP	D
---	----	----	---

soil/siding and/or stucco. The high areas were observed on the rear, right, left and front.



Rear: Foliage close to structure



Rear: High soil

C. Roof Covering Materials

Type(s) of Roof Covering: Asphalt shingles
 Viewed From: Walked the roof
 Comments:

NOTE: We recommend all repairs to the roof covering be performed by a professional, competent and qualified roofing contractor.

GUTTERS / DOWNSPOUTS

The gutters had debris/leaves accumulation. We recommend cleaning to avoid spilling roof runoff around the building – a potential source of water entry or water damage.

The house downspouts were discharging too close to the foundation. We recommend having downspouts discharge water at least five (5) feet from the house. Storm water should be encouraged to flow away from the building at the point of discharge.

SLOPED ROOFING

Damaged/tear shingles were observed on the roof. We recommend having all damaged shingles replaced to prevent further damage and water intrusion. This was noted on the rear left.

FLASHINGS

Exposed nail heads were noted at the roof protrusions and/or ridge shingles. Nail heads at either the vent & roof flashing or at the composition shingles can allow water to penetrate past the roof covering given enough time. As the exposed portion of the nail rusts, more space will become available between the nail and the roofing material for water to penetrate. This condition can usually be remedied by sealing or caulking affected areas.

A hole was observed in the soffit. We recommend having this patched/blocked to

I=Inspected NI=Not Inspected NP=Not Present D=Deficient

I	NI	NP	D
---	----	----	---

prevent pest intrusion. This was noted on the left.



Front



Gutters full



Exposed nail heads



Rear



Rear left: torn shingle



Left: hole in soffit

X			X
---	--	--	---

D. Roof Structure and Attics

Viewed From: Entered and walked all accessible attic space
 Approximate Average Depth of Insulation: 0 to 2 inches
 Comments:

NOTE: We recommend all repairs to the roof structure be performed by a professional, competent and qualified framer.

ATTIC INSULATION / VENTILATION

The pull-down stair/scuttle panel to the attic was not insulated. We recommend adding insulation for improved energy efficiency.

Per today's standards, little insulation was observed in the attic space. Insulation improvements may be cost effective, depending on the anticipated term of ownership.

ROOF STRUCTURE

Today's standards require having the purlins the same size as the roof rafters and must be supported every 4 feet. No deflection was noted within the attic space or on the exterior.

NOTE: The ridge board was undersized in the attic. Today's standards require

I=Inspected

NI=Not Inspected

NP=Not Present

D=Deficient

I	NI	NP	D
---	----	----	---

the ridge board to be at least the same height as the cut rafter. No deflection was noted within the attic space or on the exterior. The roof structure appeared to be performing as design.

Multiple steps on the pulldown stairs were broken. We recommend repair for safety reasons.



Pull-down stairs/scuttle panel lacked insulation



Pulldown stairs: Cracked steps



Undersized purlins - insufficiently supported



Attic left



Attic front



Attic right



Attic rear

X			X
---	--	--	---

E. Walls (Interior and Exterior)

Wall Materials: Exterior walls: brick veneer, wood siding, vinyl siding, interior walls: painted drywall
 Comments:

I=Inspected

NI=Not Inspected

NP=Not Present

D=Deficient

I	NI	NP	D
---	----	----	---

NOTE: We recommend all repairs/improvements/replacements to the walls be performed by a professional, competent and qualified contractor.

EXTERIOR WALLS

A step crack was observed on the exterior brick veneer. This typically is an indication of structural movement. We recommend patching and monitoring. This was noted on the rear, front, and left.

Blocked weep holes were noted at the brick veneer walls. These should be cleared to allow any possible moisture from running out. These were located on the rear.

Wood decay was observed on the exterior siding. We recommend repairs/replacement to all decayed wood to prevent further deterioration and creating conducive conditions for wood destroying insect activity. This was noted on the right.

INTERIOR WALLS

Hairline/shrinkage cracks were noted in the interior walls. This condition was mainly cosmetic in nature and should be patched. This was noted in the bedroom 2 closet, bedroom 3 closet, bathroom 2, and living room.

Wall patching was noted. This indicates previous work was performed and we recommend monitoring the area. This was observed throughout the house.

A diagonal crack was observed on an interior wall. This typically indicates foundation movement. We recommend repairing and monitoring. This was observed in the hall, bedroom 1, and 3.

Moisture staining and damage was noted and the area was confirmed with a moisture meter and infrared thermal Imager to be dry at the time of inspection. We recommend monitoring. This was observed in the garage laundry room.



Rear: blocked weep holes



Rear: step crack



Front: Step crack

I=Inspected

NI=Not Inspected

NP=Not Present

D=Deficient

I	NI	NP	D
---	----	----	---



Right: wood decay



Garage laundry room: Moisture stain and damage dry at time of inspection



Garage laundry room: Moisture stain and damage dry at time of inspection



Bedroom 1: Hairline crack



Bedroom 1: diagonal crack



Hall: Diagonal crack



Bedroom 3: Diagonal crack

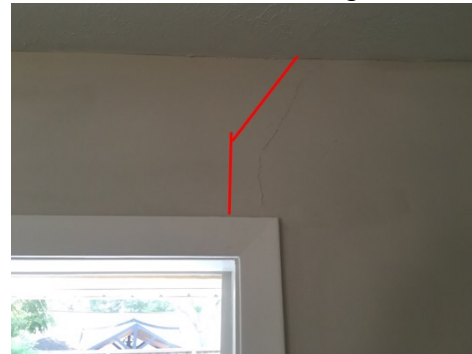

Bedroom 3: Diagonal crack

X			X
---	--	--	---

F. Ceilings and Floors

Ceiling & Floor Materials: Ceilings were made of textured drywall, floors were made of tile, wood, and carpet.

Comments:

NOTE: We recommend all repairs/improvements/replacements to the ceilings and floors be performed by a professional, competent and qualified contractor.

CEILINGS

Evidence of patching was detected which indicates previous work performed. We recommend monitoring. This was observed throughout the house.

I=Inspected NI=Not Inspected NP=Not Present D=Deficient

I	NI	NP	D
---	----	----	---

Hairline cracks which were by nature mainly cosmetic were noted on the ceiling. We recommend having these caulked and painted. This was observed in the garage.

FLOORS

Multiple areas of the floors sounded hollow when walked on. This could be an indication of the boards having unglued from the foundation. This is more of a nuisance, we recommend having the different areas reglued.



Garage: patchwork



Garage: Hairline crack

G. Doors (Interior & Exterior)

Comments:

NOTE: We recommend all repairs/improvements/replacements to the doors be performed by a professional, competent and qualified contractor.

INTERIOR DOORS

A door was noted out of square, which indicates movement within the structure, but still operate as intended. It is impossible to determine the rate of the movement in a one time inspection. We recommend monitoring the door and adjusting if needed. This was observed in bedroom 3.

A door in the house was found to be rubbing on its frame. We recommend having this adjusted so that it operates as intended. This was observed in bedroom 3.

A door in the house would not latch when shut. We recommend having the strike plate adjusted. This was noted in bathroom 2.

EXTERIOR DOORS

The front door did not close flush against the jam. We recommend having this improved to reduce air infiltration.

The screen for the sliding glass door was missing. We recommend having this replaced.

I=Inspected NI=Not Inspected NP=Not Present D=Deficient

I	NI	NP	D
---	----	----	---

Daylight was observed coming through an exterior door when closed. We recommend having this adjusted or additional weather stripping be added to prevent air infiltration. This was observed at the front door and garage man door.

The door from the garage entering into the house did not appear to be a proper fire rated door, as fire rating labels were not observed and the door had insert type cutouts that reduces the doors thickness below the required minimum of 1 3/8". We recommend having this improved.



Bedroom 3: door rubbed on frame and out of square



Bathroom 2: would not latch

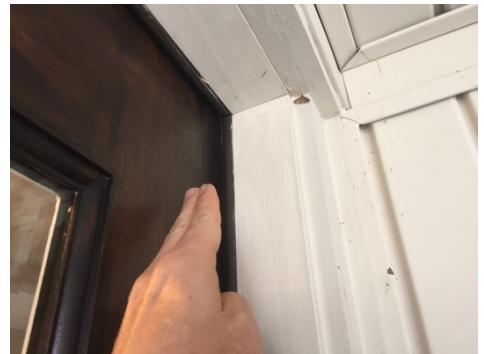

Front door: would not close flush

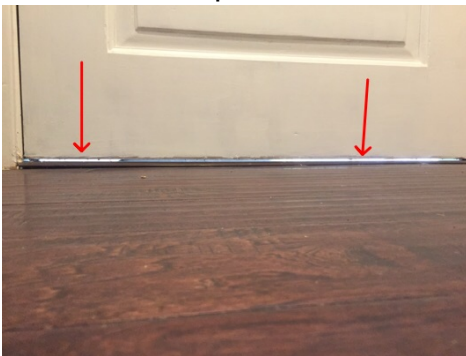

Front door: daylight coming through



Garage man door: not fire rated

H. Windows

Window Types: Aluminum, single-hung style, double pane, windows
 Comments:

NOTE: We recommend all repairs/improvements/replacements to the windows be performed by a professional, competent and qualified contractor.

The exterior and interior caulk around the windows was deteriorated and missing at some areas. We recommend repair. Exterior caulking is the first energy efficient measures to install. The purpose of exterior caulking is to minimize air flow and moisture through cracks, seams, utility penetrations and openings. Controlling air infiltration is one of the most cost effective measures in modern construction practices, a home that is not sealed will be uncomfortable due to drafts and will use about 30% more heating and cooling energy than a relatively air-tight home. In addition, good caulking and sealing will reduce dust and dirt in

I=Inspected NI=Not Inspected NP=Not Present D=Deficient

I	NI	NP	D
---	----	----	---

the home and prevent damage to structural elements.

Window hardware was loose/damaged. We recommend repair. This was noted in the bedroom 1 and bathroom 2.

Note: Per today's construction standards, bedroom windows are required to have minimum opening dimensions of 24" tall by 20" wide. The bedroom windows failed to meet the height requirement.

A window was out of square however it still operated as designed. We recommend monitoring this for future movement. This was observed in bedroom 1 at the right front window.

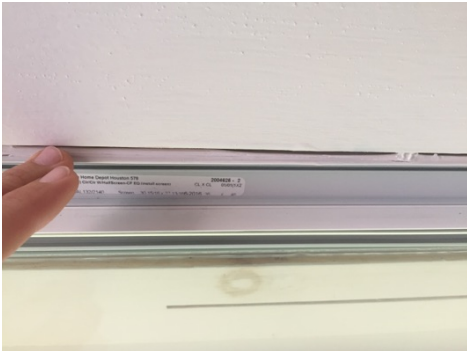

Around house: deteriorated caulk



Bedroom 1: loose hardware at left front window

<input type="checkbox"/>	<input type="checkbox"/>	<input checked="" type="checkbox"/>	<input type="checkbox"/>	I. Stairways (Interior & Exterior)
--------------------------	--------------------------	-------------------------------------	--------------------------	------------------------------------

Comments:

<input type="checkbox"/>	<input type="checkbox"/>	<input checked="" type="checkbox"/>	<input type="checkbox"/>	J. Fireplaces and Chimneys
--------------------------	--------------------------	-------------------------------------	--------------------------	----------------------------

Locations:

Types:

Comments:

<input type="checkbox"/>	<input type="checkbox"/>	<input checked="" type="checkbox"/>	<input type="checkbox"/>	K. Porches, Balconies, Decks, and Carports
--------------------------	--------------------------	-------------------------------------	--------------------------	--

Comments:

<input type="checkbox"/>	<input type="checkbox"/>	<input checked="" type="checkbox"/>	<input type="checkbox"/>	L. Other
--------------------------	--------------------------	-------------------------------------	--------------------------	----------

Materials:

Comments:

II. ELECTRICAL SYSTEMS

<input checked="" type="checkbox"/>	<input type="checkbox"/>	<input type="checkbox"/>	<input checked="" type="checkbox"/>	A. Service Entrance and Panels
-------------------------------------	--------------------------	--------------------------	-------------------------------------	--------------------------------

I=Inspected

NI=Not Inspected

NP=Not Present

D=Deficient

I NI NP D

Panel Locations: Electrical service panel was located on the rear side of the house

Materials & Amp Rating: Copper Service Conductors, 2 AWG 125 amp

Comments:

NOTE: We recommend all repairs on the electrical system and in the electrical panel be performed by a licensed, professional, competent and qualified electrician.

SERVICE PANEL

We recommend caulking the top and sides of the electrical main panel to prevent moisture intrusion.

No Arc-Fault Circuit Interrupter (**AFCI**) protection was installed to protect electrical circuits in bedrooms.

Building codes with which new homes must comply require the installation of AFCI protection of all bedroom outlets. This type of protection is designed to detect electrical arcing, which is a potential fire hazard.

Although AFCI protection was not required at the time the home was originally constructed, as general knowledge of safe building practices has improved with the passage of time, building standards have changed to reflect current understanding. We recommend considering updating the existing electrical to provide AFCI protection.

Arc-fault protection can be provided using AFCI circuit breakers installed at the main electrical panel which provide this protection to all non-AFCI outlets on the circuit controlled by that AFCI breaker.

Multiple neutral at the neutral bar were under the same terminals. Today's standards require having each neutral conductor to have its own terminal. We recommend having this improved/repared.

Multiple branch conductors were connected to circuit breakers for which the wire size were too small. There is a risk of overheating of the electrical conductors before the breakers would shut off. We recommend repair.

The breaker serving the condensing coils was oversized per the unit's manufacturer's data plate maximum rated breaker. We recommend having this repaired/replaced with an adequately sized breaker to prevent potential damage to the condensing coils.

The bonding screw was missing at the time of the inspector. Without a bonding screw, the neutral bus bar, metal cabinet, and grounding system were not bonded together. This condition is improper and we recommend repair.

SERVICE ENTRANCE

The overhead service drop conductors had inadequate height clearance from the ground. Safe building practices require the following clearances:

1. 10 feet above a walking surface (including decks and balconies).
2. 12 feet above a drive

I=Inspected

NI=Not Inspected

NP=Not Present

D=Deficient

I	NI	NP	D
---	----	----	---

3. 18 feet above a roadway.

4. 22.5 ft. above a swimming pool (water surface).

The home failed to comply with number 1.

We recommend that before the expiration of your Inspection Objection Deadline, you consult with your electrical service provider to discuss options and costs for correction.



Top and side: Caulk missing at wall connection



Rear: service panel



Rear: service panel

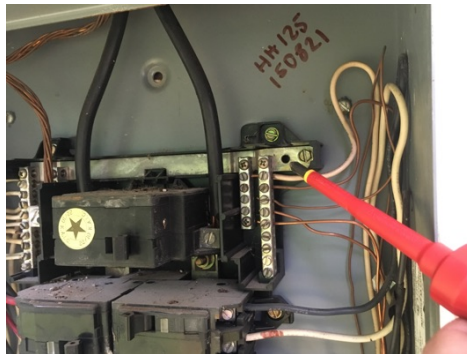
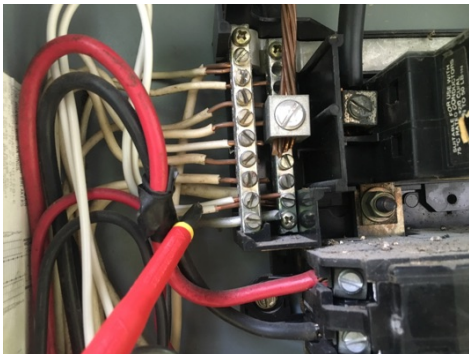

Bonding screw missing

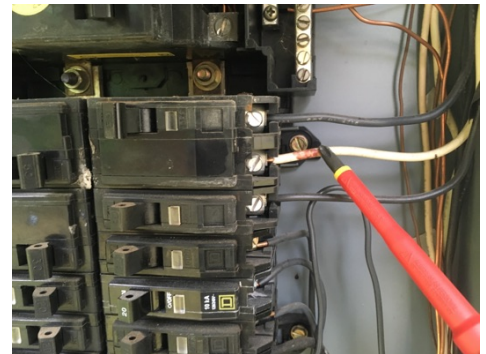

Conductor undersized for breaker



Service too low

X			X
---	--	--	---

B. Branch Circuits, Connected Devices, and Fixtures

Type of Wiring: Copper wiring

Comments:

I=Inspected

NI=Not Inspected

NP=Not Present

D=Deficient

I NI NP D

NOTE: We recommend all repairs on the electrical system and in the electrical panel be performed by a licensed, professional, competent and qualified electrician.

DISTRIBUTION WIRES

Improper electrical connections were noted, these should be improved. We recommend all electrical connections be made inside junction boxes fitted with cover plates. This was observed in the attic,

Open junction boxes leaving exposed wiring in the attic space was noted. All junction boxes should be fitted with cover plates, in order to protect the wire connections. We recommend repair.

FIXTURES

The house was not equipped with enough smoke detectors. Today's standards require having them in every sleeping room, in the vicinity of the sleeping room and on each floor level. We recommend repair as this can be safety/fire hazard. One was noted missing outside bedroom 1 and 2.

An inoperative light fixture was noted in the house. We recommend replacing the bulb. Should this not resolve the issue, we recommend having the fixture repaired/replaced. This was observed on the front porch and front of the garage.

OUTLETS

Note: Per today's construction standards, the home was not equipped with the required number of electrical outlets.

Painted outlets were noted in the house. The body and the face of the a receptacle outlet is an insulator. Its best not to coat an insulator, especially when some paints can be conductive. Electrical equipment and connection should not be damaged or contaminated by foreign materials such as paint, plaster, cleansers, abrasives, or corrosives residues as these may adversely affect safe operation or mechanical strength. We recommend having these repaired/improved. We observed this in the attic.

An **open ground** was noted in the house. We recommend having this corrected. We observed this in the garage at multiple outlets.

Electrical outlets at various areas in the home were improperly secured and moved when plugs were inserted. Outlets should be securely installed to prevent fire, shock and/or electrocution hazard. We recommend having these improved. We observed them in the bedroom 2 and 3 and the living room.

A receptacle outlet was found to not be protected by a Ground Fault Circuit Interrupter (**GFCI**) receptacle. Today's standards require GFCI protected outlets be installed in basements, crawlspaces, garages, the home exterior and interior receptacles located within 6 feet of a plumbing fixture to avoid potential electric shock or electrocution hazards. We recommend having this repaired per today's standards. This condition was observed in bathroom 1.

I=Inspected

NI=Not Inspected

NP=Not Present

D=Deficient

I	NI	NP	D
---	----	----	---

At the time of the inspection, an electrical outlet/switch cover plate was not installed. This condition left energized electrical components exposed to touch, a shock/electrocution hazard. We recommend a cover plate be installed. This was observed in the attic.



Attic: open junction box



Front porch: inoperable light fixture



Exterior outlets: Bubble cover recommended



Attic: painted outlet



Garage: open ground at multiple outlets



Bedroom 2: Loose outlet



Bathroom 1: Outlet not GFCI protected to the left of the lavatory

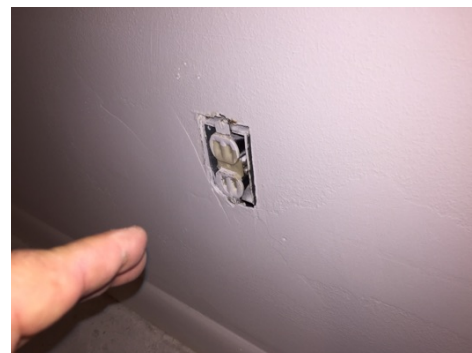

Attic: Outlet missing cover plate

III. HEATING, VENTILATION AND AIR CONDITIONING SYSTEMS

I=Inspected

NI=Not Inspected

NP=Not Present

D=Deficient

I	NI	NP	D
---	----	----	---

A. Heating Equipment

Type of Systems: Central forced air, The furnace was located in the attic
 Energy Sources: The furnace was gas powered
 Comments:

NOTE: We recommend all maintenance/repairs to the HVAC system be performed by a licensed, professional, competent and qualified HVAC technician.

FURNACE OPERATION

The equipment responded to operating controls at the thermostat when placed in the heating mode. Warm air was discharging from all supply air registers. No further equipment diagnostics were performed as part of this home inspection.

FUEL SUPPLY

The gas supply pipe contained no drip leg. A drip leg is generally recommended but not always required, depending on the local Authority Having Jurisdiction (AHJ). The purpose of a drip leg is to prevent particulates or moisture from condensation from entering and clogging the furnace gas valve, which can cause the furnace to shut down. You may wish to consult with a local licensed, professional, competent and qualified HVAC technician concerning the advisability of installing a drip leg in the gas line.

The gas shutoff valve was damaged. We recommend repair.

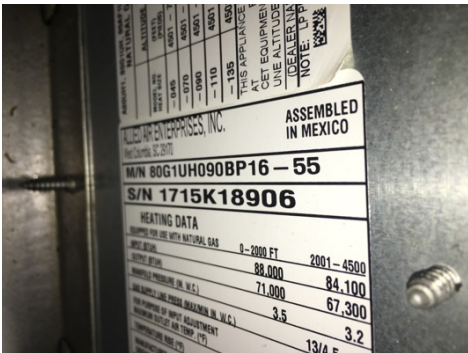

Furnace model and serial numbers

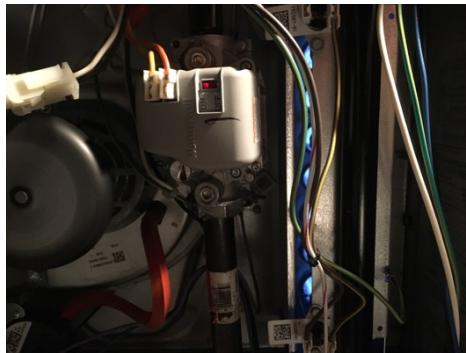

Furnace fired up



Hot air temperature



Shutoff valve damaged
 REI 7-5 (05/4/2015)



Missing drip leg

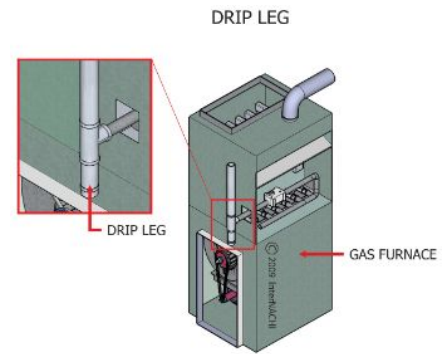

Drip leg installation

I=Inspected

NI=Not Inspected

NP=Not Present

D=Deficient

I	NI	NP	D
---	----	----	---



Hall air filter size 20x30

X			X
---	--	--	---

B. Cooling Equipment

Type of Systems: Central forced air, **split system**. The condensing coil was located on the left side of the house, the evaporating coil was located in the attic.
Comments:

NOTE: We recommend all maintenance/repairs to the HVAC system be performed by a licensed, professional, competent and qualified HVAC technician.

TEMPERATURE DIFFERENTIAL

Testing the differential temperature of the supply (vent) air and the return (ambient) air is the best test available (without releasing gasses into the environment) for diagnosing the present condition of the air conditioning equipment. The normal range is between 14.° f. & 21.° f. For a complete evaluation of the system, we recommend having the entire system inspected by a licensed, professional, competent and qualified HVAC technician.

The temperature differential was 20 degrees.

EVAPORATOR UNIT

The evaporating coils had been sealed. Cutting the seal goes beyond the scope of the home inspection. We were unable to view the condition of the coils.

The primary condensate line drained against the wall and foundation on house left side. We recommend having this relocated as it could introduce water into the structure.

I=Inspected NI=Not Inspected NP=Not Present D=Deficient

I	NI	NP	D
---	----	----	---



Evaporator unit model and serial numbers

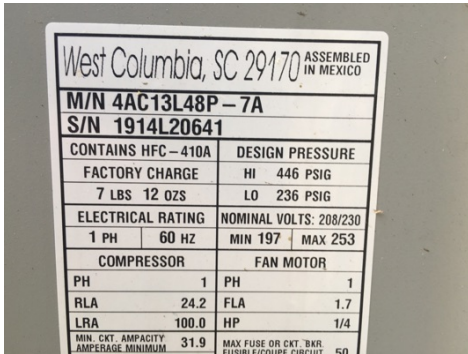

Condenser unit model and serial numbers

Primary condensate drain line draining on foundation and wall

C. Duct Systems, Chases, and Vents

Comments:

A significant temperature increase was measured at a register compared to the rest of the house. Should this affect your living comfort, we recommend having the duct further evaluated and adjusted as needed. This was noted in bathroom 1.

An active air vent/duct was observed in the garage. Today's standards do not allow for vents/returns in a garage to be connected to the rest house conditioned air as fumes could escape/be recirculated into the house. We recommend repair.



Temperature measured in bathroom 1



Garage: active vent

I=Inspected

NI=Not Inspected

NP=Not Present

D=Deficient

I NI NP D

IV. PLUMBING SYSTEM

 A. Plumbing Supply, Distribution System and Fixtures

Location of Water Meter: Front of structure
 Location of Main Water Supply Valve: Right side
 Comments:

The water supply lines in the attic were not insulated. We recommend having these insulated to prevent condensation to form on the line, which could then drip onto the insulation and eventually create **moisture stains** on the ceiling. We recommend improving the insulation condition.

Static Water Pressure Reading: 58 psi

NOTE: We recommend all maintenance/repairs to the water supply system be performed by a licensed, professional, competent and qualified plumber.

STATIC WATER PRESSURE

Home water supply pressure was within the acceptable limits of 40 pounds per square inch (PSI) and 80 PSI at the time of the inspection.

EXTERIOR

An exterior hose bibb did not have a back flow preventer. **Anti-siphon** devices keep contaminated water from entering the potable water of the house plumbing. These devices are cheap and can be found in most home improvement stores. We recommend making the upgrade. This was observed on the right, left and rear.

DISTRIBUTION PIPE MATERIAL

The home contained a combination of galvanized steel and PEX water distribution pipes. The galvanized steel pipes are outdated and subject to corrosion which will eventually result in restricted flow and leakage and will need to be replaced. We recommend you consult with a licensed, professional, competent and qualified plumbing contractor to discuss options and costs for replacement. Water flow in the home was satisfactory at the time of the inspection.

Plumbing distribution pipes in contact with each were made of different types of metal and may cause **galvanic corrosion** which will result in deterioration and eventual leakage. We recommend installation of a dielectric union by a licensed, professional, competent and qualified plumbing contractor.

BATHROOM FAUCETS

A loose faucet was noted. We recommend having this properly secured. We

I=Inspected

NI=Not Inspected

NP=Not Present

D=Deficient

I	NI	NP	D
---	----	----	---

observed this bathroom 1.

BATHROOM LAVATORIES

MAINTENANCE: A stopper was not functional at a bathroom lavatory/tub. We recommend having stoppers adjusted or repaired to retain water as it is designed. This was noted in bathroom 1 at the tub.

BATHTUBS/SHOWERS

All shower and bathtub handles, faucets, spouts and shower heads should be caulked at the wall. Be sure to caulk any gaps that may appear between the hardware & tile of the fixtures or shower enclosures. Most tile surfaces will have gaps in the grout that can also allow for water penetration past the tile work. A leak in any one of these areas can cause concealed structural damage that would not be obvious in a visual inspection.

We recommend having an escutcheon plate sealed/caulked to the wall to prevent water intrusion into the wall where it can cause damage. This was observed in bathroom 1 and 2.

KITCHEN

There was no cold water at the kitchen faucet at the time of inspection. We recommend having this further investigated to determine the cause and have any necessary repairs made.

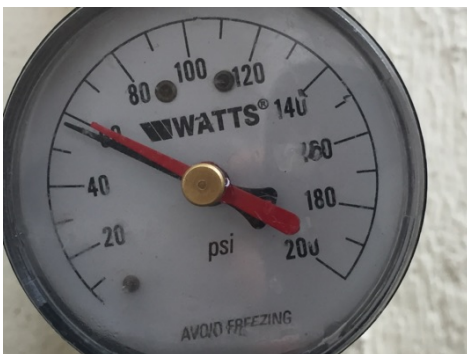

Static Water Pressure



Around house: Back flow preventer recommended

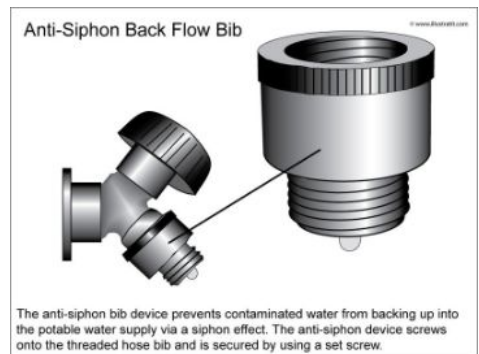

Back flow preventer

I=Inspected

NI=Not Inspected

NP=Not Present

D=Deficient

I	NI	NP	D
---	----	----	---



Right: Main Water Shutoff valve



Kitchen and bathrooms: dissimilar metals in contact



Bathroom 1: loose faucet



Bathroom 1: drain stop at tub would not retain water



Bathroom 1: missing caulk at wall protrusions



Kitchen: no cold water at faucet

X			X
---	--	--	---

B. Drains, Wastes, and Vents

Comments:

BATHROOMS

There was an unapproved, flexible, corrugated drainpipe that will contribute to blockages at a bathroom sink(s). We recommend this be replaced with the proper drain material. We observed this in bathroom 2.

A leak was noted under a tub. Water was observed seeping up from the soil indicating there was a failure of the cast iron drain. We recommend having this repaired. This was observed in bathroom

A leak was noted under a lavatory at the drain. We recommend having this repaired. This was observed in bathroom 1 and 2.

Note: The home was equipped with cast iron drains. Cast iron drains have a typical life expectancy of approximately 50 years when installed under ground and 60-70 years when installed above ground. These drain pipes are not commonly used today because the sewer gases corrode the interior of the pipe which eventually leads to restrictions in the pipe and failure. We recommend consulting with a plumber about getting these replaced with an approved drain material.

I=Inspected

NI=Not Inspected

NP=Not Present

D=Deficient

I	NI	NP	D
---	----	----	---

KITCHEN

A drain line was improperly sloped at bathroom/kitchen sink. We recommend having this improved to ensure all water drains as it should. This was found in the kitchen.



Right rear: cast iron drains



Bathroom 1: water under tub near drain

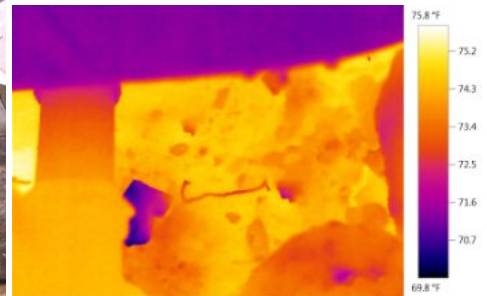

Bathroom 1: water under tub near drain



Bathroom 1: leak at drain stem



Bathroom 1: water on cabinet floor from leak at drain



Bathroom 1: water on cabinet floor from leak at drain



Bathroom 2: leak at drain



Bathroom 2: water on cabinet floor from leak at drain



Bathroom 2: water on cabinet floor from leak at drain

I=Inspected

NI=Not Inspected

NP=Not Present

D=Deficient

I	NI	NP	D
---	----	----	---



Bathroom 2: corrugated drain line



Garage: cast iron drain



Kitchen: improperly sloped drain line

X			X	C. Water Heating Equipment
---	--	--	---	----------------------------

Energy Source: Water heater was gas powered, located in the garage
 Capacity: Unit was 40 gallons
 Comments:

NOTE: We recommend all maintenance/repairs to the water heating equipment be performed by a licensed, professional, competent and qualified plumber.

PRESSURE RELIEF VALVE

WARNING: REINSPECTION OF T&P RELIEF VALVE: Temperature and Pressure Relief Valves should be reinspected AT LEAST ONCE EVERY THREE YEARS by a licensed plumbing contractor or authorized inspection agency, to insure that the product has not been affected by corrosive water conditions and to insure that the valve and discharge line have not been altered or tampered with illegally. Certain naturally occurring conditions may corrode the valve or its components over time, rendering the valve inoperative. Such conditions are not detectable unless the valve and its components are physically removed and inspected. Do not attempt to conduct this inspection on your own. Contact your plumbing contractor for a reinspection to assure continuing safety. FAILURE TO REINSPECT THIS VALVE AS DIRECTED COULD RESULT IN UNSAFE TEMPERATURE OR PRESSURE BUILD-UP WHICH CAN RESULT IN SERIOUS INJURY OR DEATH AND/OR SEVERE PROPERTY DAMAGE.

DRIP PAN

Although the water heater was installed in a location in which leakage of the tank or plumbing connections would cause damage to the structure, no drip pan was installed. We recommend a proper drip pan be installed to prevent possible water damage.

EXHAUST FLUE

The storm collar at the roof level on the flue was installed too high which left a gap between the flue and the flashing. This could allow for water intrusion into the structure. We recommend repair.

I=Inspected

NI=Not Inspected

NP=Not Present

D=Deficient

I	NI	NP	D
---	----	----	---

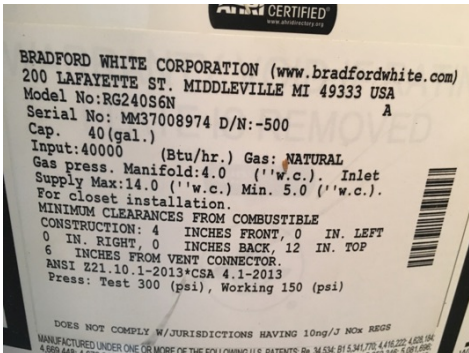

Model and Serial numbers



FYI: Test TPR Valve yearly



Missing safety pan

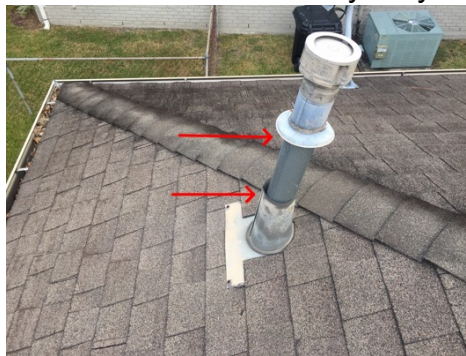

Storm collar too high

<input type="checkbox"/>	<input type="checkbox"/>	<input checked="" type="checkbox"/>	<input type="checkbox"/>
--------------------------	--------------------------	-------------------------------------	--------------------------

D. Hydro-Massage Therapy Equipment

Comments:

<input checked="" type="checkbox"/>	<input type="checkbox"/>	<input type="checkbox"/>	<input checked="" type="checkbox"/>
-------------------------------------	--------------------------	--------------------------	-------------------------------------

E. Other

Materials: GAS LINE

Comments:

An uncapped gas line was observed at the time of inspection. We recommend having this capped when not in use to prevent accidental valve opening. This was observed in the garage laundry room.



I=Inspected

NI=Not Inspected

NP=Not Present

D=Deficient

I	NI	NP	D
---	----	----	---

V. APPLIANCES

<input checked="" type="checkbox"/>	<input type="checkbox"/>	<input type="checkbox"/>	<input checked="" type="checkbox"/>	A. Dishwashers
-------------------------------------	--------------------------	--------------------------	-------------------------------------	----------------

Comments:

The electrical connection to the dishwasher was improper at the time of the inspection. The dishwasher should either be powered by an approved appliance cord plugged into a dedicated outlet or be wired directly to a main electrical or sub-panel, with properly spliced connections housed within a junction box with a cover installed. We recommend correction be made by a qualified contractor.

The dishwasher was not operated at the time of inspection. The drain knock out at the garbage disposal had not been removed. We recommend having this operated when the knock out has been removed.



Model and Serial numbers



Drain Knock out at garbage disposal still in place

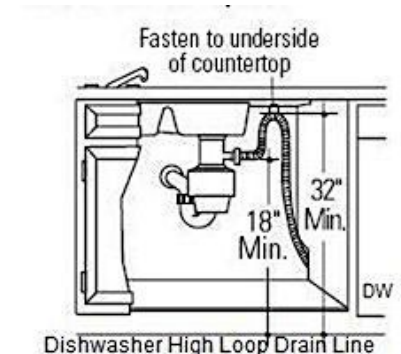

Proper drain line installation

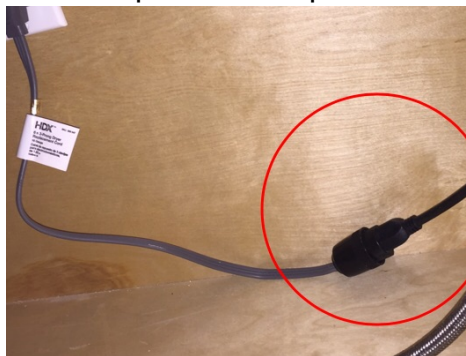

Improper electrical connection

<input checked="" type="checkbox"/>	<input type="checkbox"/>	<input type="checkbox"/>	<input type="checkbox"/>	B. Food Waste Disposers
-------------------------------------	--------------------------	--------------------------	--------------------------	-------------------------

Comments:

The garbage disposer was functioning as designed under its normal operating mode, at the time of the inspection.

I=Inspected NI=Not Inspected NP=Not Present D=Deficient

I	NI	NP	D
---	----	----	---



Model and Serial numbers

C. Range Hood and Exhaust Systems

Comments:

The range hood was excessively noisy at the time of inspection. We recommend having this further investigated to determine the cause and have any necessary repairs made.

The range top had a re-circulating vent. The air is filtered, and then it is re-deposited in the kitchen. Most vent-hood appliances, especially ones that use gas, will have a flue which is terminated outside of the house to remove combustion products, moisture, grease, and heat. The installation of a flue will also lower your electric bill during the hot months.

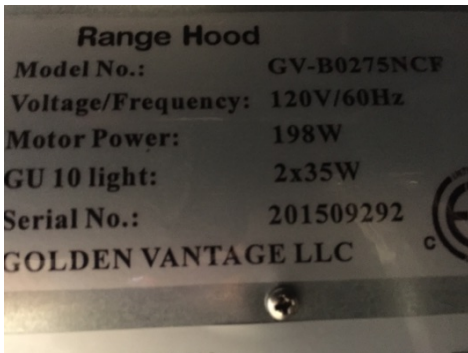

Model and Serial numbers



CLICK TO PLAY: noisy range hood

D. Ranges, Cooktops, and Ovens

Comments:

RANGE

The oven was turned on bake with the thermostat set on 350 degrees. The unit heated within the acceptable 25 degrees range with a temperature of 352 degrees.

The cooktop functioned as intended under its normal operating mode at the time of inspection.

I=Inspected

NI=Not Inspected

NP=Not Present

D=Deficient

I	NI	NP	D
---	----	----	---

The range was not properly secured to the surrounding cabinet or wall. Children can tip the oven over if the door is used as a stepping stool. All ovens are now required to be secured in some fashion. An anti-tip device should be installed.

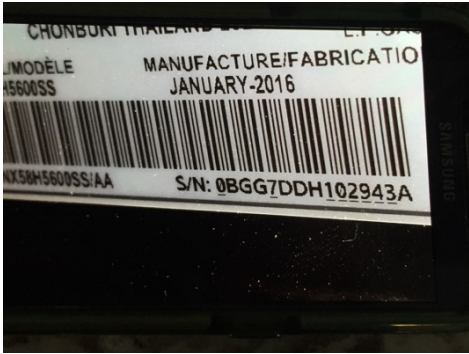

Oven model and serial numbers



Oven temperature when set on bake at 350 degrees



All burners on high

<input type="checkbox"/>	<input type="checkbox"/>	<input checked="" type="checkbox"/>	<input type="checkbox"/>	E. Microwave Ovens
--------------------------	--------------------------	-------------------------------------	--------------------------	--------------------

Comments:

There was no microwave installed at the time of inspection.

<input checked="" type="checkbox"/>	<input type="checkbox"/>	<input type="checkbox"/>	<input type="checkbox"/>	F. Mechanical Exhaust Vents and Bathroom Heaters
-------------------------------------	--------------------------	--------------------------	--------------------------	--

Comments:

The bathroom fan functioned as intended under its normal operating mode.

Although the bathroom had a window, no exhaust fan was installed to exhaust moist air.

This condition is likely to result in excessively high humidity levels especially in the summers when opening the windows would not be recommend due to elevated outdoor humidity. Elevated moisture levels may cause a number of problems, such as deterioration of materials and shower wall tile detachment. High humidity can also encourage the growth of microbes such as mold fungi. Excessive growth of mold fungi can produce high concentrations of mold spores in indoor air which can cause serious health problems in some people.

We recommend you consider installation of an exhaust fan in this bathroom to prevent problems from excessively high humidity. This was observed in bathroom 1.

<input checked="" type="checkbox"/>	<input type="checkbox"/>	<input type="checkbox"/>	<input checked="" type="checkbox"/>	G. Garage Door Operators
-------------------------------------	--------------------------	--------------------------	-------------------------------------	--------------------------

Door Type: Roll-up door

Comments:

FUNCTION

The garage door 1 had no automatic opener installed at the time of the inspection.

I=Inspected

NI=Not Inspected

NP=Not Present

D=Deficient

I	NI	NP	D
---	----	----	---

AUTOMATIC REVERSE

The photo sensor to the right garage door was installed at a height greater than 6 inches. (they were in the attic). Safety standards designed to protect small children limit the maximum mounting height for garage door photo sensors at 6 inches. We recommend correction by a qualified contractor.



Photo eye sensor in the attic were more than 6" off ground

X			
---	--	--	--

H. Dryer Exhaust Systems

Comments:

GENERAL CONDITION

The dryer vent was found to be clear at the time of inspection.



Dryer vent clear

		X	
--	--	---	--

I. Other

Observations:

I=Inspected

NI=Not Inspected

NP=Not Present

D=Deficient

I NI NP D

Glossary

Term	Definition
AFCI	AFCIs (Arc Fault Circuit Interrupters) are newly developed electrical devices designed to protect against fires caused by arcing faults in the home's wiring. Arc faults can be created by damaged, deteriorated, or worn electrical plugs, cords, and/or branch circuit conductors.
Flashing	"Flashing" is a general term used to describe sheet metal fabricated into shapes used to protect areas of the roof from moisture intrusion. Typically, flashing will be installed in areas such as roof and wall penetrations such as vent pipes, chimneys, skylights and transition areas where dissimilar roofing materials or different roof slopes meet. Flashing is also used at windows and decks.
GFCI	Ground Fault Circuit Interrupter(GFCI), is an electrical safety device that cuts power to an individual outlet and/or entire circuit when as little as .005 amps of current imbalance is detected. At the time of original construction GFCI's may not have been installed in all the locations where they are now required but their absence will be reported for your information.
anti-siphon	Anti-siphon devices help to prevent cross contamination from a hose into the public or private water supply system.
attic insulation	A house with poor insulation will have increased heating and cooling costs. During the heating season homes with poorly insulated attics or roofs will lose heat through the ceiling or roof more quickly than resulting in increased heating costs. During the cooling season homes with poorly insulated attics or roofs will experience higher indoor temperatures as heat from the roof-covering material radiates downward into the living space. Air sealing and attic access insulation is also an important factor in having a good insulation system installed.
exposed nail heads	Exposed nails will rust and shrink and allow moisture intrusion into the wood and attic below. These leaks can go unnoticed for a long period of time causing rot and mold issues. All exposed nail heads should be with a sealant compatible with the roofing or flashing material should installed.
galvanic corrosion	Galvanic corrosion (also known as bimetallic corrosion or dissimilar-metal corrosion) is an electrochemical disintegration that occurs when dissimilar metals come in contact with each other while immersed in an electrolyte. Galvanic corrosion is of major concern anywhere moisture can reach metal building components.

I=Inspected NI=Not Inspected NP=Not Present D=Deficient

I	NI	NP	D
---	----	----	---

moisture stains	Moisture stains indicate that there is or has been moisture intrusion. Moisture stains are tested with a moisture meter to try and determine if active leaking is present. When elevated moisture is present the source of the moisture should be located and all necessary repairs be made. If there are no elevated moisture levels the issue may have been corrected. Consultation with the seller to determine if action regarding the issue has taken place is recommended. Only a water test or a more invasive inspection can determine the cause at times.
open ground	A ground wire provides a path for stray electrical current to follow and is an important safety feature. Modern wiring codes require all outlets and fixtures to be grounded, meaning a separate conductor must be provided for current to follow in the event the wiring is compromised. An open ground means the safety path is open, or incomplete.
slab foundation	This residence has a SLAB foundation. Such foundations vary considerably from older ones that have no moisture barrier under them and no reinforcing steel within them to newer ones that have both. Our inspection of slab foundations conforms to industry standards, which is that of a generalist and not a specialist. We check the visible portion of the stem walls on the outside for any evidence of significant cracks or structural deformation, but we do not move furniture or lift carpeting and padding to look for cracks or moisture penetration, and we do not use any of the specialized devices that are used to establish relative elevations and confirm differential movement. Significantly, many slabs are built or move out of level, but the average person may not become aware of this until there is a difference of more than one inch in twenty feet, which most authorities regard as being tolerable. Many slabs are found to contain cracks when the carpet and padding are removed, including some that contour the edge and can be quite wide. They typically result from shrinkage and usually have little structural significance. However, there is no absolute standard for evaluating cracks, and those that are less than 1/4" and which exhibit no significant vertical or horizontal displacement are generally not regarded as being significant. However, in the absence of any major defects, we may not recommend that you consult with a foundation contractor, a structural engineer, or a geologist, but this should not deter you from seeking the opinion of any such expert.
split system	A split system is present when the cabinet housing the compressor, cooling fan and condensing coils is located physically apart from the evaporator coils. As is typical with split systems, the compressor/condenser cabinet is typically located at the exterior. The evaporator coils designed to collect heat from the home interior are typically located in an interior cabinet.

Report Summary

STRUCTURAL SYSTEMS		
Page 9 Item: D	Roof Structure and Attics	Multiple steps on the pulldown stairs were broken. We recommend repair for safety reasons.
ELECTRICAL SYSTEMS		
Page 16 Item: A	Service Entrance and Panels	<p>Multiple branch conductors were connected to circuit breakers for which the wire size were too small. There is a risk of overheating of the electrical conductors before the breakers would shut off. We recommend repair.</p> <p>The breaker serving the condensing coils was oversized per the unit's manufacturer's data plate maximum rated breaker. We recommend having this repaired/replaced with an adequately sized breaker to prevent potential damage to the condensing coils.</p> <p>The bonding screw was missing at the time of the inspector. Without a bonding screw, the neutral bus bar, metal cabinet, and grounding system were not bonded together. This condition is improper and we recommend repair.</p> <p>SERVICE ENTRANCE</p> <p>The overhead service drop conductors had inadequate height clearance from the ground. Safe building practices require the following clearances:</p> <ol style="list-style-type: none"> 1. 10 feet above a walking surface (including decks and balconies). 2. 12 feet above a drive 3. 18 feet above a roadway. 4. 22.5 ft. above a swimming pool (water surface). <p>The home failed to comply with number 1. We recommend that before the expiration of your Inspection Objection Deadline, you consult with your electrical service provider to discuss options and costs for correction.</p>
Page 18 Item: B	Branch Circuits, Connected Devices, and Fixtures	<p>A receptacle outlet was found to not be protected by a Ground Fault Circuit Interrupter (GFCI) receptacle. Today's standards require GFCI protected outlets be installed in basements, crawlspaces, garages, the home exterior and interior receptacles located within 6 feet of a plumbing fixture to avoid potential electric shock or electrocution hazards. We recommend having this repaired per today's standards. This condition was observed in bathroom 1.</p> <p>At the time of the inspection, an electrical outlet/switch cover plate was not installed. This condition left energized electrical components exposed to touch, a shock/electrocution hazard. We recommend a cover plate be installed. This was observed in the attic.</p>
HEATING, VENTILATION AND AIR CONDITIONING SYSTEMS		

Page 20 Item: B	Cooling Equipment	The primary condensate line drained against the wall and foundation on house left side. We recommend having this relocated as it could introduce water into the structure.
PLUMBING SYSTEM		
Page 23 Item: A	Plumbing Supply, Distribution System and Fixtures	KITCHEN There was no cold water at the kitchen faucet at the time of inspection. We recommend having this further investigated to determine the cause and have any necessary repairs made.
Page 25 Item: B	Drains, Wastes, and Vents	A leak was noted under a tub. Water was observed seeping up from the soil indicating there was a failure of the cast iron drain. We recommend having this repaired. This was observed in bathroom A leak was noted under a lavatory at the drain. We recommend having this repaired. This was observed in bathroom 1 and 2. Note: The home was equipped with cast iron drains. Cast iron drains have a typical life expectancy of approximately 50 years when installed under ground and 60-70 years when installed above ground. These drain pipes are not commonly used today because the sewer gases corrode the interior of the pipe which eventually leads to restrictions in the pipe and failure. We recommend consulting with a plumber about getting these replaced with an approved drain material. KITCHEN A drain line was improperly sloped at bathroom/kitchen sink. We recommend having this improved to ensure all water drains as it should. This was found in the kitchen.
Page 27 Item: C	Water Heating Equipment	DRIP PAN Although the water heater was installed in a location in which leakage of the tank or plumbing connections would cause damage to the structure, no drip pan was installed. We recommend a proper drip pan be installed to prevent possible water damage. EXHAUST FLUE The storm collar at the roof level on the flue was installed too high which left a gap between the flue and the rashing . This could allow for water intrusion into the structure. We recommend repair.
Page 27 Item: E	Other	An uncapped gas line was observed at the time of inspection. We recommend having this capped when not in use to prevent accidental valve opening. This was observed in the garage laundry room.
APPLIANCES		
Page 28 Item: A	Dishwashers	The dishwasher was not operated at the time of inspection. The drain knock out at the garbage disposal had not been removed. We recommend having this operated when the knock out has been removed.

Page 30 Item: D	Ranges, Cooktops, and Ovens	The range was not properly secured to the surrounding cabinet or wall. Children can tip the oven over if the door is used as a stepping stool. All ovens are now required to be secured in some fashion. An anti-tip device should be installed.
Page 31 Item: G	Garage Door Operators	AUTOMATIC REVERSE The photo sensor to the right garage door was installed at a height greater than 6 inches. (they were in the attic). Safety standards designed to protect small children limit the maximum mounting height for garage door photo sensors at 6 inches. We recommend correction by a qualified contractor.